

Lifting Chain

Product Catalogue

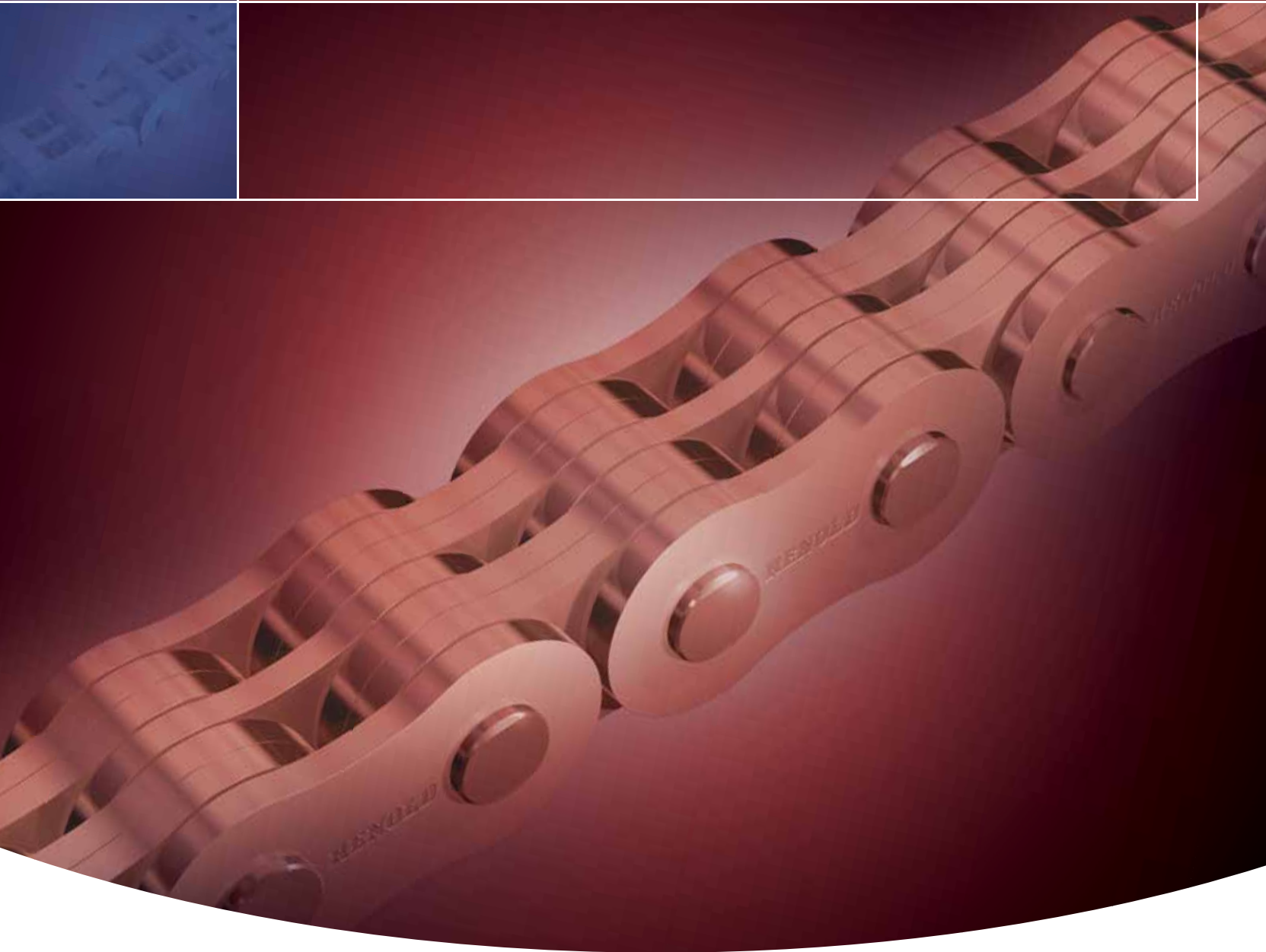

RENOLD
Superior Chain Technology

Renold Chain Product Range



Roller Chain

- British, ANSI, API, DIN, ISO and Works Standard Chains
- Adapted Chains
- Extended Pitch Chains
- Hollow Pin Chains
- Made to Order, Special Chains
- Mini Pitch Chains
- Nickel Plated Chains
- Oilfield Chains
- Plastic Bush Chains
- Power and Free Chains
- Polymer Block Chains
- Side Bow Chains
- Stainless Steel Chains

Applications

- Abattoirs • Air Conditioning • Aircraft - Civil & Military • Bakery Machines • Battery Manufacturing
- Brewing • Canning • Carpet Machines • Chart Tables/Marine • Chocolate Manufacturing
- Concrete Moulding Equipment • Copying Machines • Dairy Machinery • Drying Machinery
- Earth Moving Equipment • Extrusion Machines • Filtration Plants • Food & Drink Manufacture
- Glass Manufacture • Health Care Equipment • Hydraulic Components • Ice-Cream Manufacture
- In-flight Refueling • Ingot Casting & Scrap Metal Processing • Latex Machinery • Laundry Machinery
- Lawnmower Manufacture • Mill Machinery • Mining • MOT Brake Testing Machinery • Nuclear Power
- Off Road Vehicles • Oil Industry • Packaging Machines • Paper & Card Making • Paper Shredders
- Plastic Machinery • Potato Grading Machinery • Power Generation • Printing Machines • Quarry Plant
- Road Making & Plant Machinery • Robotic Systems • Roof Tile Manufacture • Ship's Engines
- Silkscreen Machinery • Ski-Lifts • Soot Blowers • Steel Making • Straddle Carriers • Sugar Beet Machines
- Sun-Blinds • Telecommunications • Textile Machinery • Timber and Woodworking Machines
- Tin Printer Ovens • Tobacco/Cigarette Machinery • Tunnelling Machines • T.V. and Audio Equipment
- Tyre Manufacture • Waste Handling • X-Ray Equipment



Conveyor Chain

- British, ISO and Works Standard Chains
- Adapted Chains
- Agricultural Chains
- Bakery Chains
- Deep Link Chains
- Escalator Chains
- Made to Order, Specials
- Stainless Steel Chains
- Sugar Cane Chains
- Zinc Plated Chains

Applications

- Abattoirs • Agricultural Machines • Bakery Machines • Bottle Washing Plants
- Brick & Tile Machinery OEM • Car Plants • Cement Plants • Chemical Plants • Chicken Process Equipment
- Cigarette/Tobacco Machinery • Dust Filters • Egg Sorting Conveyors • Electrical Switchgears • Escalators
- Extrusion Machines • Feed Mill Machines • Feed Silo Equipment • Fibreglass Industry • Filtration Plants
- Fish Conveyor • Food Sterilisation • Food Processing • Freezing Equipment • Freezing Tunnels • Glass Manufacturing
- Grain Conveyor • Harvesting Machines • Ice Cream Machines • Induction Furnaces • Ingot Casting & Scrap Metal Processing Mfr
- Latex Machinery • Leisure Rides • Luggage & Parcel Handling • Machine Tools • Mail Sorting • Metal Casting • Mushroom Compost Machinery • Nuclear • Ovens/Provers
- Potato Grading Machinery • Potting Machinery • Quarries • Radio Astronomy • Roof Tile Manufacture
- Rope Machinery • Saw Mill Equipment • Sewage Plants • Shaker Conveyors • Ski-Lifts • Sluice Gates
- Steel Making • Sugar Factories • Swarf Conveyors • Textile Machinery • Timber & Woodworking Machines
- Tool Changer • Tunnelling Machines • Tyre Manufacture • Washing & Sterilising Machines
- Water Treatment • Wire Belts



Lifting Chain

- LH(BL), AL, LL and Works Standard Chains

Applications

- Bottle Washing Plants • Cement Plants • Chemical • Counterbalance Sets • Cranes
- Dust/Swarf Conveyors • Elevators • Food Processing • Food Sterilisation • Fork Lift Trucks
- Pipe Line Valves/Taps • Printing Machines • Rock Drilling • Straddle Carriers • Sun-Blinds • Tail Lifts

Table of Contents

Leaf/LFT Chain

Renold Ultimate Specification	4
Leaf Chain LH (BL) Series - NFE26107 / ISO4347 / DIN8152 / ANSI B29.8	5
Leaf Chain AL Series - ANSI B29.8	6
Leaf Chain LL Series - NFE26107 / ISO4347 / DIN8152	7
Leaf Chain Works Standard	8

Roller Chain

ANSI Standard Chain - ISO606 A Series / ANSI B29.8	9
Large Pitch and Heavy Series Chain - ISO606 / ANSI B29.100	10
European BS Standard Chain - BS226 / ISO606 / DIN8187	11

Lifting Chain Installation and Maintenance

Introduction	12
Types of Lifting Chain	12
Chain Numbering	12
Equipment Needed	12
Preparation	13
Checking Alignment	13
Installation of Chain	13
Test Run	13
Maintenance Schedule	13
Chain Protection	14
Lubrication	14
Environmental Factors	14
To Measure Chain Wear	15
Riveting Chain	15
Chain Matching	15
Repair and Replacement	16
Disconnecting Chain	16-17
Safety Warnings	17
Safety Warning FLT Chain	18
Modes of Failure	18

Troubleshooting 19 - 21

Special Applications 22

Leaf/FLT Chain

Renold Ultimate Specification

Special design features

- High Fatigue Strength
- Long Service Life
- Maximum Resistance to wear
- Compact Design

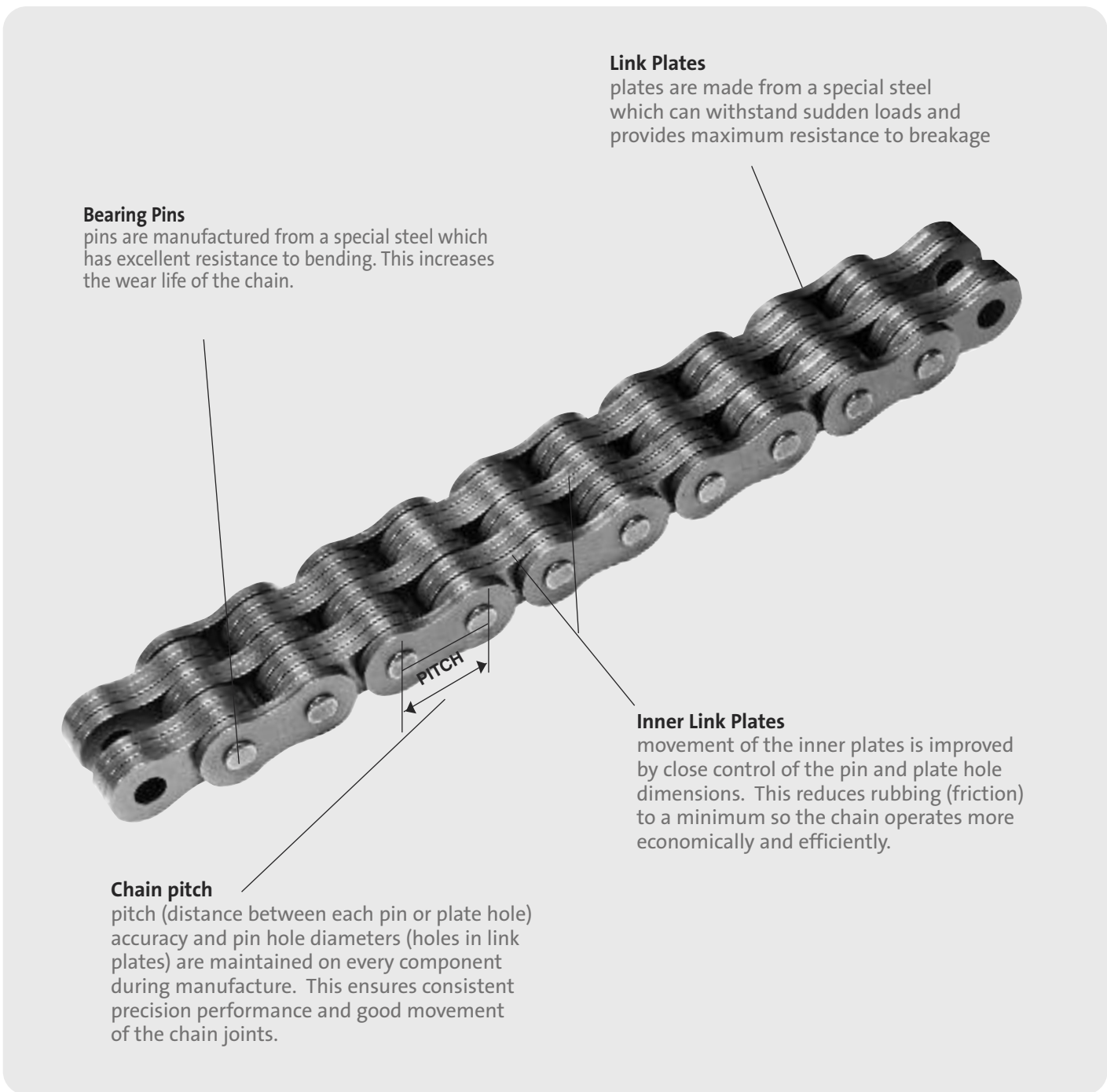

Bearing Pins
pins are manufactured from a special steel which has excellent resistance to bending. This increases the wear life of the chain.

Link Plates
plates are made from a special steel which can withstand sudden loads and provides maximum resistance to breakage

Inner Link Plates
movement of the inner plates is improved by close control of the pin and plate hole dimensions. This reduces rubbing (friction) to a minimum so the chain operates more economically and efficiently.

Chain pitch
pitch (distance between each pin or plate hole) accuracy and pin hole diameters (holes in link plates) are maintained on every component during manufacture. This ensures consistent precision performance and good movement of the chain joints.

Leaf Chain LH (BL) Series

NFE26107 / ISO4347 / DIN8152 / ANSI B29.8

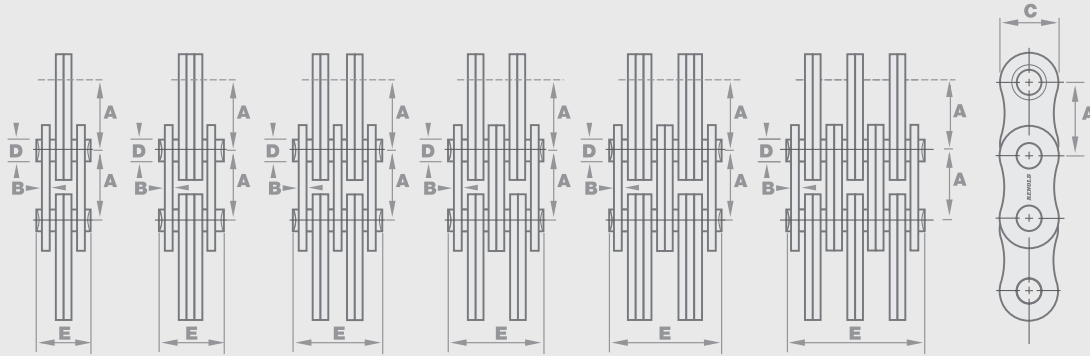

Plate Combination 2x2 2x3 3x4 4x4 4x6 6x6

Chain Ref.		Technical Details (mm)									
ISO Ref.	ANSI Ref.	Pitch (inch)	Pitch (mm)	Plate Combination	Chain Length over 100 pitches (± 0.25%)	Plate Width	Plate Depth	Pin Diam.	Width Over Pin	Tensile Strength (Newtons)	Weight (kg/m)
		NOM	NOM	A		MAX	MAX	MAX	MAX	MIN	
			A	A		B	B	C	D	E	
LH0822	BL 422	0.500	12.700	2x2	1270	2.06	12.1	5.08	10.9	27800	0.60
LH0823	BL 423	0.500	12.700	2x3	1270	2.06	12.1	5.08	13.0	27800	0.75
LH0834	BL 434	0.500	12.700	3x4	1270	2.06	12.1	5.08	17.2	42500	1.04
LH0844	BL 444	0.500	12.700	4x4	1270	2.06	12.1	5.08	19.3	58000	1.20
LH0846	BL 446	0.500	12.700	4x6	1270	2.06	12.1	5.08	23.5	58000	1.46
LH0866	BL 466	0.500	12.700	6x6	1270	2.06	12.1	5.08	27.8	90000	1.74
LH0888	BL 488	0.500	12.700	8x8	1270	2.06	12.1	5.08	36.3	110000	2.56
LH1023	BL 523	0.625	15.875	2x3	1587	2.46	15.1	5.95	15.0	40100	1.05
LH1034	BL 534	0.625	15.875	3x4	1587	2.46	15.1	5.95	19.9	60000	1.47
LH1044	BL 544	0.625	15.875	4x4	1587	2.46	15.1	5.95	22.4	78000	1.69
LH1046	BL 546	0.625	15.875	4x6	1587	2.46	15.1	5.95	27.3	78000	2.07
LH1066	BL 566	0.625	15.875	6x6	1587	2.46	15.1	5.95	32.3	120000	2.67
LH1223	BL 623	0.750	19.050	2x3	1905	3.23	18.2	7.93	20.0	60000	1.84
LH1234	BL 634	0.750	19.050	3x4	1905	3.23	18.2	7.93	26.3	101500	2.58
LH1244	BL 644	0.750	19.050	4x4	1905	3.23	18.2	7.93	29.6	126000	2.95
LH1246	BL 646	0.750	19.050	4x6	1905	3.23	18.2	7.93	36.5	126000	3.70
LH1266	BL 666	0.750	19.050	6x6	1905	3.23	18.2	7.93	43.0	190000	4.30
LH1623	BL 823	1.000	25.400	2x3	2540	4.06	23.9	9.53	24.2	100000	2.55
LH1634	BL 834	1.000	25.400	3x4	2540	4.06	23.9	9.53	32.6	152000	3.56
LH1644	BL 844	1.000	25.400	4x4	2540	4.06	23.9	9.53	36.7	186000	4.10
LH1646	BL 846	1.000	25.400	4x6	2540	4.06	23.9	9.53	45.0	186000	5.10
LH1666	BL 866	1.000	25.400	6x6	2540	4.06	23.9	9.53	53.2	285000	6.20
LH2023	BL 1023	1.250	31.750	2x3	3175	4.88	29.6	11.10	28.7	142000	4.25
LH2034	BL 1034	1.250	31.750	3x4	3175	4.88	29.6	11.10	38.6	244000	6.01
LH2044	BL 1044	1.250	31.750	4x4	3175	4.88	29.6	11.10	43.6	284000	6.80
LH2046	BL 1046	1.250	31.750	4x6	3175	4.88	29.6	11.10	53.5	305000	8.40
LH2066	BL 1066	1.250	31.750	6x6	3175	4.88	29.6	11.10	63.4	417000	10.20
LH2434	BL 1234	1.500	38.100	3x4	3810	5.68	35.9	12.71	45.1	245000	8.70
LH2446	BL 1246	1.500	38.100	4x6	3810	5.68	35.9	12.71	62.5	371500	12.40
LH2466	BL 1266	1.500	38.100	6x6	3810	5.68	35.9	12.71	74.2	454000	14.80
LH2834	BL 1434	1.750	44.450	3x4	4445	6.38	41.9	14.28	51.2	316000	11.00
LH2846	BL 1446	1.750	44.450	4x6	4445	6.38	41.9	14.28	71.0	427500	15.20
LH3234	BL 1634	2.000	50.800	3x4	5080	7.18	47.8	17.46	58.5	440400	14.00
LH3244	BL 1644	2.000	50.800	4x4	5080	7.18	47.8	17.46	66.0	579000	17.40
LH3246	BL 1646	2.000	50.800	4x6	5080	7.18	47.8	17.46	81.0	579000	21.60
LH3266	BL 1666	2.000	50.800	6x6	5080	7.18	48.3	17.46	96.0	868000	25.90
LH3288	BL 1688	2.000	50.800	8x8	5080	7.18	48.3	17.46	125.0	1157000	34.50

Other sizes available on request.
Standard end links and fixings are available. Details on request.

Leaf Chain AL Series

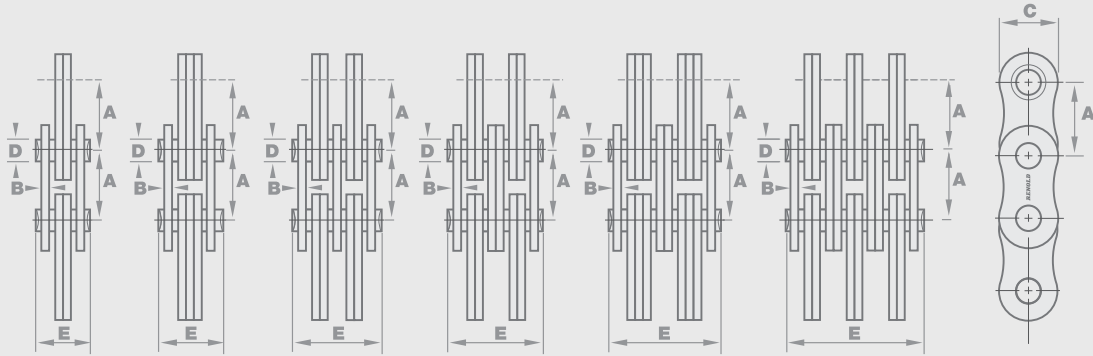

Plate Combination 2x2 2x3 3x4 4x4 4x6 6x6

Chain Ref.	Technical Details (mm)									
ANSI Ref.	Pitch (inch)	Pitch (mm)	Plate Combination	Chain Length over 100 pitches (± 0.25%)	Plate Width	Plate Depth	Pin Diam.	Width Over Pin	Tensile Strength (Newtons)	Weight (kg/m)
	NOM	NOM			MAX	MAX	MAX	MAX	MIN	
	A	A			B	C	D	E		
AL 422	0.500	12.700	2x2	1257	1.55	9.7	3.97	8.0	17000	0.35
AL 444	0.500	12.700	4x4	1257	1.55	9.7	3.97	14.8	34000	0.68
AL 466	0.500	12.700	6x6	1257	1.55	9.7	3.97	21.1	51000	1.01
AL 544	0.625	15.875	4x4	1578	2.06	12.8	5.08	18.8	58000	1.20
AL 566	0.625	15.875	6x6	1578	2.06	12.8	5.08	27.2	90000	1.79
AL 622	0.750	19.050	2x2	1893	2.45	15.3	5.95	12.6	40000	0.88
AL 644	0.750	19.050	4x4	1893	2.45	15.3	5.95	22.4	80000	1.73
AL 666	0.750	19.050	6x6	1893	2.45	15.3	5.95	32.5	120000	2.57
AL 822	1.000	25.400	2x2	2525	3.06	20.2	7.93	15.6	70000	1.45
AL 844	1.000	25.400	4x4	2525	3.06	20.2	7.93	28.2	145000	2.84
AL 866	1.000	25.400	6x6	2525	3.06	20.2	7.93	40.8	200000	4.24
AL 1044	1.250	31.750	4x4	3165	4.02	25.3	9.53	36.7	200000	4.68
AL 1066	1.250	31.750	6x6	3165	4.02	25.3	9.53	53.2	300000	6.99
AL 1244	1.500	38.100	4x4	3808	4.88	30.7	11.10	43.4	245000	6.65
AL 1266	1.500	38.100	6x6	3808	4.88	30.7	11.10	63.5	368000	9.94

Other sizes available on request.
Standard end links and fixings are available. Details on request.

Leaf Chain LL Series

NFE26107 / ISO4347 / DIN8152

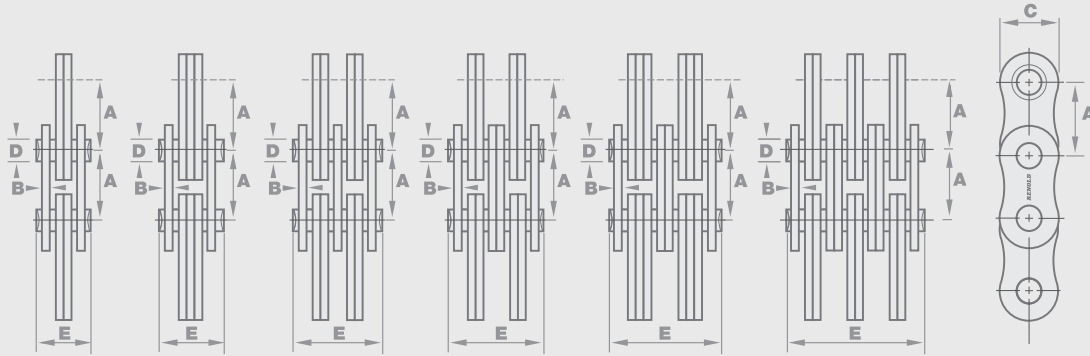

Plate Combination 2x2 2x3 3x4 4x4 4x6 6x6

Chain Ref.	Technical Details (mm)									
ISO Ref.	Pitch (inch)	Pitch (mm)	Plate Combination	Chain Length over 100 pitches ($\pm 0.25\%$)	Plate Width	Plate Depth	Pin Diam.	Width Over Pin	Tensile Strength (Newtons)	Weight (kg/m)
	NOM	NOM			MAX	MAX	MAX	MAX	MIN	
	A	A			B	C	D	E		
LL 0822	0.500	12.700	2x2	1259	1.69	10.7	4.45	8.9	21000	0.44
LL 0844	0.500	12.700	4x4	1259	1.69	10.7	4.45	15.9	42000	0.87
LL 0866	0.500	12.700	6x6	1259	1.69	10.7	4.45	22.8	64000	1.30
LL 1022	0.625	15.875	2x2	1577	1.55	12.8	5.08	8.9	22700	0.47
LL 1044	0.625	15.875	4x4	1577	1.55	12.8	5.08	15.6	45400	0.92
LL 1066	0.625	15.875	6x6	1577	1.55	12.8	5.08	22.2	68100	1.36
LL 1222	0.750	19.050	2x2	1892	1.81	14.8	5.72	10.0	32000	0.62
LL 1244	0.750	19.050	4x4	1892	1.81	14.8	5.72	17.8	64000	1.21
LL 1266	0.750	19.050	6x6	1892	1.81	14.8	5.72	24.8	96000	1.79
LL 1622	1.000	25.400	2x2	2532	3.06	20.2	8.27	15.5	72000	1.42
LL 1644	1.000	25.400	4x4	2532	3.06	20.2	8.27	28.1	144000	2.79
LL 1666	1.000	25.400	6x6	2532	3.06	20.2	8.27	40.5	216000	4.15
LL 2022	1.250	31.750	2x2	3157	3.56	25.3	10.17	18.2	95000	2.03
LL 2044	1.250	31.750	4x4	3157	3.56	25.3	10.17	33.4	190000	4.00
LL 2066	1.250	31.750	6x6	3157	3.56	25.3	10.17	47.9	285000	5.96
LL 2422	1.500	38.100	2x2	3797	5.08	30.7	14.63	25.4	170000	3.60
LL 2444	1.500	38.100	4x4	3797	5.08	30.7	14.63	46.8	340000	7.07
LL 2466	1.500	38.100	6x6	3797	5.08	30.7	14.63	68.2	510000	10.53
LL3244	2.00	50.80	4x4	5124	6.45	42.29	17.81	61.00	520,000	12.60
LL4066	2.50	63.50	6x6	6405	8.25	52.96	22.89	111.10	1,080,000	30.20
LL4088*	2.50	63.50	8x8	6405	8.25	52.96	22.89	139.00	1,440,000	38.70

Other sizes available on request.

Standard end links and fixings are available. Details on request.

* LL4088 is not covered by ISO 4347

Leaf Chain Works Standard

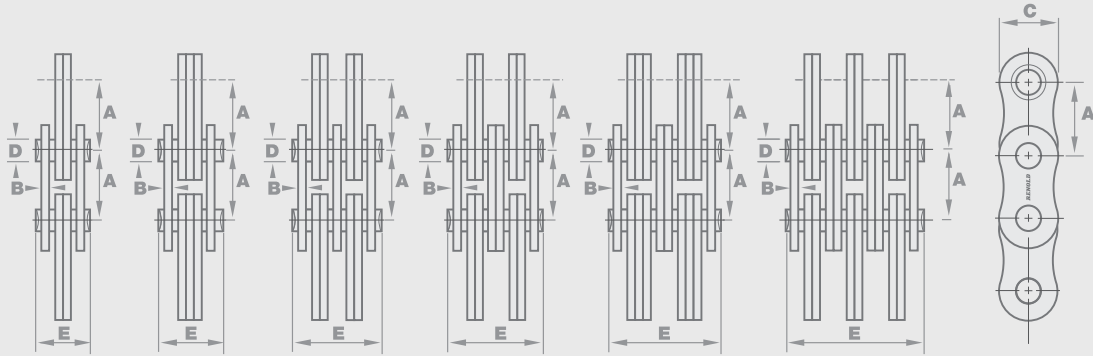

Plate Combination 2x2 2x3 3x4 4x4 4x6 6x6

Chain Ref.		Technical Details (mm)									
Renold Chain No.	ANSI Ref.	Pitch (inch)	Pitch (mm)	Plate Combination	Chain Length over 100 pitches (± 0.25%)	Plate Width	Plate Depth	Pin Diam.	Width Over Pin	Tensile Strength (Newtons)	Weight (kg/m)
		NOM	NOM			MAX	MAX	MAX	MAX	MIN	
		A	A			B	C	D	E		
1400023	1234	0.500	12.700	3x4	1259	1.69	10.70	4.45	14.20	31000	0.71
1400026	1256	0.500	12.700	5x6	1259	1.69	10.70	4.45	21.10	53000	1.10
1400030	1288	0.500	12.700	8x8	1259	1.69	10.70	4.45	30.00	85000	1.60
1400034	1523	0.625	15.875	2x3	1580	1.94	12.70	5.08	12.10	29000	0.69
1400035	1534	0.625	15.875	3x4	1580	1.94	12.70	5.08	16.00	46000	0.94
1400036	1544	0.625	15.875	4x4	1580	1.94	12.70	5.08	18.10	58000	1.07
1400037	1545	0.625	15.875	4x5	1580	1.94	12.70	5.08	20.30	58000	1.22
1400039	1556	0.625	15.875	5x6	1580	1.94	12.70	5.08	24.00	72000	1.47
1400040	1566	0.625	15.875	6x6	1580	1.94	12.70	5.08	25.90	87000	1.60
1400041	1567	0.625	15.875	6x7	1580	1.94	12.70	5.08	27.80	90000	1.74
1400042	1578	0.625	15.875	7x8	1580	1.94	12.70	5.08	32.50	101000	2.00
1400043	1588	0.625	15.875	8x8	1580	1.94	12.70	5.08	34.00	115000	2.15
1400606	LL1223	0.750	19.050	2x3	1892	1.81	14.80	5.72	12.00	32000	0.82
1400548	LL1234	0.750	19.050	3x4	1892	1.81	14.80	5.72	16.00	48000	1.14
1400607	LL1245	0.750	19.050	4x5	1892	1.81	14.80	5.72	19.70	64000	1.47
1400608	LL1256	0.750	19.050	5x6	1892	1.81	14.80	5.72	22.90	80000	1.70
1400609	LL1267	0.750	19.050	6x7	1892	1.81	14.80	5.72	26.70	96000	2.00
1400610	LL1278	0.750	19.050	7x8	1892	1.81	14.80	5.72	30.30	112000	2.30
1400048	1944	0.750	19.050	4x4	1891	2.29	14.80	5.72	21.30	73000	1.20
1400051	1966	0.750	19.050	6x6	1891	2.29	14.80	5.72	30.30	110000	1.78
1400054	1988	0.750	19.050	8x8	1891	2.29	14.80	5.72	40.00	140000	2.40
1400058	2523	1.000	25.400	2x3	2532	3.06	20.20	8.27	18.60	72000	1.65
1400059	2534	1.000	25.400	3x4	2532	3.06	20.20	8.27	25.30	108000	2.27
1400061	2545	1.000	25.400	4x5	2532	3.06	20.20	8.27	31.60	144000	2.93
1400062	2556	1.000	25.400	5x6	2532	3.06	20.20	8.27	37.20	180000	3.54
1400064	2567	1.000	25.400	6x7	2532	3.06	20.20	8.27	43.60	216000	4.20
1400065	2578	1.000	25.400	7x8	2532	3.06	20.20	8.27	50.00	252000	4.47
1400066	2588	1.000	25.400	8x8	2532	3.06	20.20	8.27	52.80	290000	5.20
1400071	3144	1.250	31.750	4x4	3154	4.16	22.80	10.17	37.90	214000	4.05
1400074	3166	1.250	31.750	6x6	3154	4.16	22.80	10.17	55.00	304000	6.04
1400082	3844	1.500	38.100	4x4	3806	5.55	30.70	14.63	49.10	360000	7.37
160244	-	2.000	50.800	4x4	5077	7.14	47.63	20.32	73.66	667200	17.58
160266	-	2.000	50.800	6x6	5077	7.14	47.63	20.32	103.38	934100	26.00
160288	-	2.000	50.800	8x8	5077	7.14	47.63	20.32	133.10	1245000	34.32
160388	-	3.000	76.200	8x8	7617	7.14	73.03	34.67	160.02	1842000	61.02
160300	-	3.000	76.200	10x10	7617	7.14	73.03	34.67	189.61	2342000	74.41

Other sizes available on request.
Standard end links and fixings are available. Details on request.

ANSI Standard Chain

ISO606 A Series / ANSI B29.8

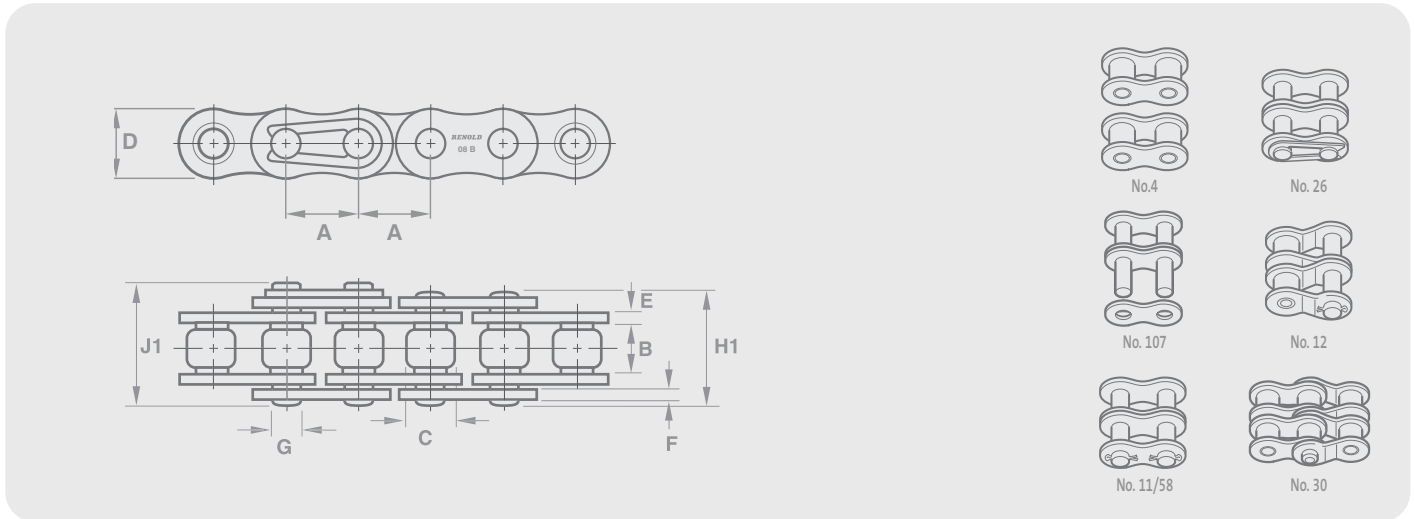

Chain Ref.		Technical Details (mm)											Connecting Links								
Renold Chain No.	ANSI No.	Pitch (inch)	Pitch (mm)	Inside Width	Roller Diam.	Plate Height	Plate Width Inner	Plate Width Outer	Pin Diam.	Pin Length	Conn. Link Extension	Transverse Pitch	ISO606 Tensile Strength (Newtons)	Weight kg/m	No. 4	No. 107	No. 11	No. 26	No. 58	No. 12	No. 30
		A	A	B	C	D	E	F	G	H1	J	K	MIN								
25R	25-1	0.250	6.350	3.10	3.30	5.90	0.76	0.76	2.30	7.9	1.2	-	3500	0.12	✓	✓	-	✓	-	-	✓
35R	35-1	0.375	9.525	4.68	5.08	8.60	1.29	1.29	3.59	12.0	1.7	-	7900	0.35	✓	✓	-	✓	-	✓	✓
40R	40	0.500	12.700	7.85	7.92	11.20	1.55	1.55	3.97	16.4	2.1	-	13900	0.60	✓	✓	✓	✓	-	✓	✓
41R	41	0.500	12.700	6.35	7.77	9.91	1.30	1.30	3.59	14.5	2.1	-	6700	0.42	✓	✓	-	✓	-	✓	✓
50R	50-1	0.625	15.875	9.40	10.16	14.60	2.04	2.04	5.08	20.4	2.7	-	21800	1.00	✓	✓	✓	✓	-	✓	✓
60R	60-1	0.750	19.050	12.57	11.91	17.50	2.45	2.45	5.94	25.3	2.6	-	31300	1.47	✓	✓	✓	✓	-	✓	✓
80R	80-1	1.000	25.400	15.75	15.88	24.13	3.25	3.25	7.94	32.7	3.0	-	55600	2.80	✓	✓	✓	-	✓	✓	✓
100R	100-1	1.250	31.750	18.90	19.05	30.17	4.06	4.06	9.54	39.7	4.2	-	87000	4.20	✓	✓	✓	-	✓	✓	-
120R	120-1	1.500	38.100	25.23	22.23	36.20	4.80	4.80	11.11	49.3	5.3	-	125000	5.70	✓	✓	✓	-	✓	✓	-
140R	140-1	1.750	44.450	25.23	25.40	42.23	5.61	5.61	12.71	52.9	5.2	-	170000	7.80	✓	✓	✓	-	✓	✓	-
160R	160-1	2.000	50.800	31.55	28.58	48.26	6.35	6.35	14.29	63.1	6.5	-	223000	10.40	✓	✓	✓	-	✓	✓	-
180R	180-1	2.250	57.150	35.48	35.71	54.30	7.11	7.11	17.46	70.6	7.9	-	281000	13.94	✓	✓	✓	-	✓	✓	-
200R	200-1	2.500	63.500	37.85	39.67	60.33	8.13	8.13	19.85	76.9	9.0	-	347000	17.30	✓	✓	✓	-	✓	✓	-

Large Pitch and Heavy Series Chain

ISO606 / ANSI B29.100

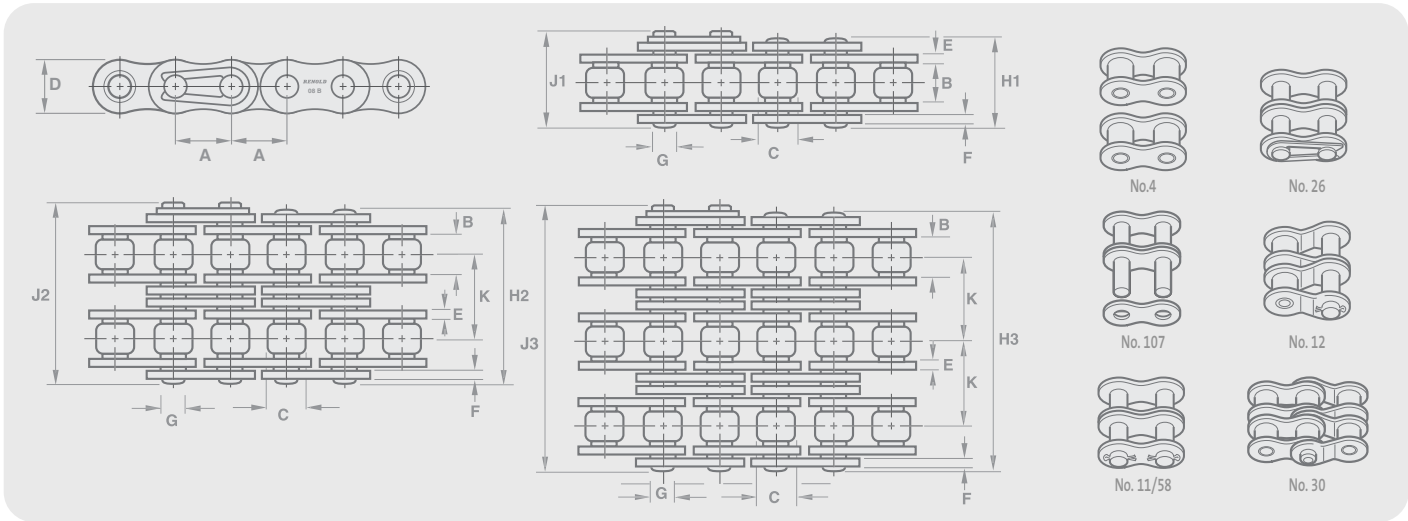

Chain Ref.		Technical Details (mm)											Connecting Links									
Renold Chain No.	ISO Ref.	Pitch (inch)	Pitch (mm)	Inside Width	Roller Diam.	Plate Height	Plate Width Inner	Plate Width Outer	Pin Diam.	Pin Length	Conn. Link Extension	Transverse Pitch	ISO606 Tensile Strength (Newtons)	Weight	No. 4	No. 107	No. 11	No. 26	No. 58	No. 12	No. 30	
				MIN	MAX	MAX	MAX	MAX	MAX	MAX	MAX	NOM	MIN	kg/m								

ANSI large pitch chain - simplex

		A	A	B	C	D	E	F	G	H1	J	K										
140R	140-1	1.75	44.45	25.23	25.40	42.23	5.61	5.61	12.71	54.90	7.40	-	170000	7.80	✓	✓	✓	-	✓	✓	-	-
160R	160-1	2.00	50.80	31.55	28.58	48.26	6.35	6.35	14.29	65.50	7.90	-	223000	10.40	✓	✓	✓	-	✓	✓	-	-
180R	180-1	2.25	57.15	35.48	35.71	54.30	7.11	7.11	17.46	73.90	9.10	-	281000	13.94	✓	✓	✓	-	✓	✓	-	-
200R	200-1	2.50	63.50	37.85	39.67	60.33	8.13	8.13	19.85	80.30	10.20	-	355000	17.30	✓	✓	✓	-	✓	✓	-	-
240R	240-1	3.00	76.20	47.35	47.62	72.39	9.80	9.80	23.80	95.50	10.50	-	500000	25.00	✓	✓	✓	-	✓	✓	-	-

ANSI large pitch chain - duplex

		A	A	B	C	D	E	F	G	H2	J	K										
140-2R	140-2	1.75	44.45	25.23	25.40	42.23	5.61	5.61	12.71	103.60	7.40	48.87	340000	15.50	✓	✓	✓	-	✓	✓	-	-
160-2R	160-2	2.00	50.80	31.55	28.58	48.26	6.35	6.35	14.29	121.60	7.90	58.55	446000	20.60	✓	✓	✓	-	✓	✓	-	-
180-2R	180-2	2.25	57.15	35.48	35.71	54.30	7.11	7.11	17.46	140.80	9.10	65.84	562000	27.72	✓	✓	✓	-	✓	✓	-	-
200-2R	200-2	2.50	63.50	37.85	39.67	60.33	8.13	8.13	19.85	151.90	10.20	71.55	630000	34.40	✓	✓	✓	-	✓	✓	-	-
240-2R	240-2	3.00	76.20	47.35	47.62	72.39	9.80	9.80	23.80	183.33	10.50	87.83	1000800	50.00	✓	✓	✓	-	✓	✓	-	-

HV series - simplex

		A	A	B	C	D	E	F	G	H3	J	K										
140HV-1R	140HV-1	1.75	44.45	25.23	25.40	41.81	6.35	6.35	12.71	57.90	7.40	-	258000	8.60	RL	PL	CL	PLA				
160HV-1R	160HV-1	2.00	50.80	31.55	28.58	47.73	7.11	7.11	14.29	68.50	7.90	-	311400	11.20	RL	CL	PL	PLA				
180HV-1R	180HV-1	2.25	57.15	35.48	35.71	53.51	8.13	8.13	17.46	73.90	9.10	-	422500	15.20	RL	CL	PL	PLA				
200HV-1R	200HV-1	2.50	63.50	37.85	39.67	59.56	9.65	9.65	19.85	86.40	10.20	-	600500	19.50	✓	✓	✓	-	✓	-	-	-

HV series - duplex

		A	A	B	C	D	E	F	G	H3	J	K										
140HV-2R	140HV-2	1.75	44.45	25.23	25.40	41.81	6.35	6.35	12.71	106.90	7.40	48.87	516000	16.74	PL	CL	PLA	RL				
160HV-2R	160HV-2	2.00	50.80	31.55	28.58	47.73	7.11	7.11	14.29	130.40	7.90	61.90	622800	23.50	RL	CL	PL	PLA				

V series - simplex

		A	A	B	C	D	E	F	G	H3	J	K										
140V-1R	140V-1	1.75	44.45	25.23	25.40	41.81	5.61	5.61	12.71	54.90	7.40	-	235000	7.80	✓	✓	✓	-	✓	-	-	-
160V-1R	160V-1	2.00	50.80	31.55	28.58	47.73	6.35	6.35	14.29	65.50	7.90	-	289000	10.40	✓	✓	✓	-	✓	-	-	-
180V-1R	180V-1	2.25	57.15	35.48	35.71	53.51	7.11	7.11	17.46	73.90	9.10	-	382500	13.94	✓	✓	✓	-	✓	-	-	-
200V-1R	200V-1	2.50	63.50	37.85	39.67	59.56	8.13	8.13	19.85	80.30	10.20	-	445000	17.30	✓	✓	✓	-	✓	-	-	-

V series - duplex

		A	A	B	C	D	E	F	G	H3	J	K										
140V-2R	140V-2	1.75	44.45	25.23	25.40	41.81	5.61	5.61	12.71	103.60	7.40	48.87	470000	15.50	✓	✓	✓	-	✓	-	-	-

Cottered chain is available on request.

European (BS) Standard Chain

BS226 / ISO606 / DIN8187

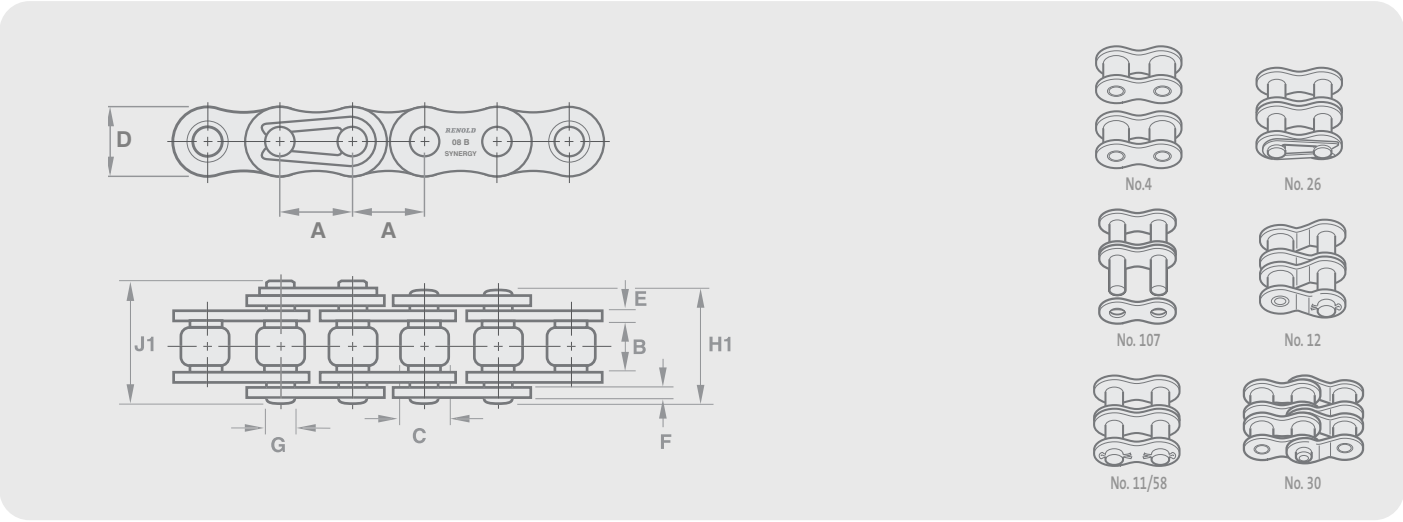

Chain Ref.		Technical Details (mm)											Connecting Links								
Renold Chain No.	ISO No.	Pitch (inch)	Pitch (mm)	Inside Width	Roller Diam.	Plate Height	Plate Width Inner	Plate Width Outer	Pin Diam.	Pin Length	Conn. Link Extension	Transverse Pitch	ISO606 Tensile Strength (Newtons)	Weight kg/m	No. 4	No. 107	No. 11	No. 26	No. 58	No. 12	No. 30
		A	A	B	C	D	E	F	G	H1	J	K	MIN								
1141*	-	-	4.000	2.70	2.50	4.10	0.57	0.57	1.65	6.8	1.2	-	1800	0.07	✓	✓	✓	-	-	-	-
1151	03	-	5.000	2.50	3.20	4.10	0.57	0.57	1.49	7.4	2.5	-	2200	0.08	✓	✓	-	✓	-	✓	-
1161	04	-	6.000	2.80	4.00	5.00	0.57	0.57	1.85	7.4	2.9	-	3000	0.12	✓	✓	-	✓	-	✓	-
110500	05B-1	0.315	8.000	3.00	5.00	7.11	0.73	0.73	2.31	8.6	3.1	-	5000	0.18	✓	✓	-	✓	-	✓	-
110037	-	0.375	9.525	3.94	6.35	8.26	1.30	1.04	3.28	10.9	3.3	-	11100	0.34	✓	✓	-	✓	-	✓	-
GY0681	06B-1	0.375	9.525	5.72	6.35	8.26	1.30	1.04	3.28	13.5	3.3	-	11100	0.39	✓	✓	-	✓	-	✓	-
111044	-	0.500	12.700	3.30	7.75	9.90	1.10	0.95	4.09	9.8	3.9	-	8900	0.30	✓	✓	-	✓	-	✓	-
111046	-	0.500	12.700	4.88	7.75	9.90	1.10	0.95	4.09	11.4	3.9	-	8900	0.35	✓	✓	-	✓	-	✓	-
110044	-	0.500	12.700	5.21	8.51	11.81	1.55	1.55	4.45	14.2	3.9	-	19000	0.62	✓	✓	-	✓	-	✓	-
GY0881	08B-1	0.500	12.700	7.75	8.51	11.81	1.55	1.55	4.45	17.0	3.9	-	19000	0.70	✓	✓	-	✓	-	✓	-
110054	-	0.625	15.875	6.50	10.16	14.70	1.55	1.55	5.08	16.0	4.1	-	23000	0.81	✓	✓	-	✓	-	✓	-
GY1081	10B-1	0.625	15.875	9.65	10.16	14.73	1.55	1.55	5.08	18.8	4.1	-	23000	0.92	✓	✓	-	✓	-	✓	-
GY1281	12B-1	0.750	19.050	11.68	12.07	16.13	1.80	1.80	5.72	22.7	4.6	-	30500	1.20	✓	✓	-	✓	-	✓	-
GY1681	16B-1	1.000	25.400	17.02	15.88	21.08	4.12	3.10	8.28	36.1	5.4	-	67000	2.80	✓	✓	-	✓	✓	-	-
GY2081	20B-1	1.250	31.750	19.56	19.05	26.42	4.62	3.61	10.19	43.2	6.1	-	98070	3.85	✓	✓	-	✓	✓	-	-
GY2481	24B-1	1.500	38.100	25.40	25.40	33.40	6.10	5.08	14.63	53.4	6.6	-	166700	7.45	✓	✓	✓	-	✓	-	-
110147	28B-1	1.750	44.450	30.99	27.94	37.08	7.62	6.35	15.90	65.1	7.4	-	200000	9.35	✓	✓	✓	-	✓	-	-
110166	32B-1	2.000	50.800	30.99	29.21	42.29	7.11	6.35	17.81	67.4	7.9	-	255000	10.10	✓	✓	✓	-	✓	-	-
110206	40B-1	2.500	63.500	38.10	39.37	52.96	8.64	8.13	22.89	82.6	10.2	-	372700	16.50	✓	✓	✓	-	✓	-	-
180709	-	3.000	76.200	45.72	48.26	63.88	12.19	10.16	29.24	99.1	10.5	-	578266	25.80	✓	✓	✓	-	-	-	-
180781	-	3.500	88.900	53.34	53.98	77.85	13.72	12.45	34.30	114.6	11.7	-	778435	35.20	✓	✓	✓	-	-	-	-
110325	-	4.000	101.600	60.96	63.50	90.17	15.24	13.72	39.40	130.9	13.0	-	711800	49.30	✓	✓	✓	-	-	-	-
180807	-	4.500	114.300	68.58	72.39	104.14	17.27	16.00	44.48	147.4	14.3	-	1378942	63.40	✓	✓	✓	-	-	-	-

* Bush chain.

Chain Installation and Maintenance

Introduction

Renold Chain has over 100 years experience in the operation and maintenance of lifting chain. Involvement with designers, manufacturers and users of all types of equipment has enabled Renold to develop this concise manual for chain lifting applications.

This definitive manual is designed to pass on the preferred methods of correct handling, adjustment, installation and maintenance of lifting chain systems resulting in maximum chain life.

Renold can supply leaf chain for use in machine tool applications. If you require chain for this purpose, please ensure that you state this clearly on your correspondence.

If further information is required, please contact our technical sales staff.

Types of Lifting Chain

There are three main categories of lifting chain covered by this guide. Of these the most popular is leaf chain also referred to as Fork Lift Truck (FLT) chain since it is used in large quantities on this type of application.

Leaf Chain

Made from interlaced plates connected with a hardened pin. Defined in ISO4347 latest edition.

These chains cannot be used with sprockets since there is no means of engagement. Leaf chains have a greater strength/weight ratio than Roller chains.

Roller Chain

Conventional pin, roller and bush construction normally used for transmission applications but easily adapted for lifting purposes. Defined in ISO 606 latest edition.

Heavy duty ANSI chains with thick side plates are particularly suitable for lifting applications.

Bush Chain

Identical to roller chain but with the omission of the roller. The main disadvantage is that sprocket/ bush wear can be rapid in highly loaded applications.

Chain Numbering

Leaf Chain

Renold chain conforms to International standards and can be ordered using the ISO or ANSI Part Number.

The letters prefixing the part number refer to the root transmission chain standard, as shown below:

- LH = Chain based on ISO4347 (ANSI Chain)
- BL = Identical to LH (North American terminology)
- LL = Chain based on ISO4347 (European Type)
- AL = Obsolete standard. No longer covered by ISO or ANSI standards.

Example BL646. (or LH1246.)

The left hand numbers refer to the chain pitch size in 1/8 (or 1/16 for LH) inch units i.e. 3/4" pitch. The right hand numbers refer to the chain lacing i.e. 4 x 6.

Roller Chain

The ANSI standard number system consists of at least two or three digits and possibly a suffix. The left hand digit or digits refer to the pitch size in 1/8 inch units. The right hand number refers to the chain style. For multiple strand chains a dash and a number is added.

Example ANSI 60H

i.e. 3/4" pitch roller chain - heavy series.

The ISO standard number system consists of at least two or three digits and a suffix. The digits refer to the pitch size in 1/16 inch units. The right hand number refers to the chain style.

For example:

1" Pitch ISO 16B - European Type

For Multiple Strand chains, add a dash and the number of strands, e.g. 16B-3.

Equipment Needed

The breaking of roller and bush chain can be achieved by using a Renold Chain Extractor, these being:

- 311015 for light industrial chains up to 0.5" pitch
- 10101 for chains from 0.375" to 0.625" pitch
- 10102 for chains from 0.75" to 1.25" pitch European and 0.75" to 1" ANSI

Pin heads will need to be removed using a hand grinder on all types of leaf chain and larger roller and bush chains.

For joining any chain up to 2.5" pitch, a drift punch will be required. Note however that it is not recommended that the user attempts to join lengths of FLT chain.

Erection of medium or heavy chain systems requires millwrighting equipment such as lifting tackle, slings, wedges, packing etc.

Other Useful Equipment

- Straight edges and/or strong, fine line
- Spirit level
- Plumb line
- Selection of hammers, files, key blanks, etc
- Hand Grinding Machine



Chain Installation and Maintenance

Preparation

Check equipment to ensure that general requirements are correct (e.g. sprockets, sheaves, means of adjustment).

Check condition and rigidity of the shafts and bearings, particularly if there has been considerable previous service. Replace or rectify if necessary.

Drive/headshaft/sprockets should be checked to ensure they are level, parallel and square with any slides or bearings.

Use a spirit level and adjustable comparator bar or micrometer between shafts at extreme points on each side of the drive. Rectify any parallelism error present.

Place sprockets or respective shafts in approximate alignment and fit the keys in accordance with correct engineering practice. Do not finally secure keys at this stage.

Care must be taken with sprockets of split design to ensure perfect abutting of the faces of each half. Proceed with the key fitting after the halves are finally bolted together, otherwise the key can prevent correct assembly and subsequently result in malgearing.

It should be verified that key heads will not project beyond the width of any cases, guards or guides.

Checking Alignment

Accurate alignment of shafts, sheaves and sprocket tooth faces provides a uniform distribution of load across the entire chain width and contributes substantially to maximum drive life.

Use a straight edge in several different positions, if possible, as a check against wobble. A nylon or similar line is a good substitute for a straight edge particularly on longer centre distances.



Installation of Chain

Should endwise float of shafts be present, make due allowances so that alignment is correct at the mid position of float.

When alignment is correct within closest practical limits, drive any keys home and take a final check.

When sheaves are used it should be checked that the chain sits comfortably between the flanges with equal clearance on both sides.

Pins should not rub on the sheave flanges.

Renold Chain should not be assembled into the system until attention has been paid to cleanliness of the sprocket teeth and sheave working area, particularly if debris of an abrasive nature (cement dust, weld spatter etc.) has been prevalent whilst work was in progress.

Ensure the chain is clean and free from debris and place around the sprockets or sheave, observing instructions where matched strands are involved. Ensure that the strength of tackle is sufficient to hold the chain. Chain weights are shown in the Renold catalogue. Do not detach any tackle until the chain is completely assembled.

Never paint a chain since this will prevent the penetration of maintenance lubricant.

Adjustment

After chain installation ensure that all fastenings have been properly tightened.

Carry out any adjustment operations to ensure that all chains are equally loaded.

Test Run

It is advisable to give the system a short test run for the following reasons:

- To check for correct operation
- To ensure there is no cross binding and all chains are carrying an equal load
- To check for any unusual noise or vibration

Maintenance Schedule

Regular chain maintenance is important if maximum life is to be achieved. In a correctly sized and installed system with adequate maintenance lubrication, the chain is expected to last for approximately 6,000 hours or 3 years whichever is shorter.

The following maintenance schedule is suggested.

Regularly

- Check chain adjustment/load sharing and rectify if necessary
- Check for smooth operation while under load in both lifting and lowering directions
- Check for wear on side plates (Max 5% of plate height)
- Check for evidence for twist or side bow
- Check for damaged or cracked plates
- Check for chain elongation (Max 3% FLT chain, 2% Roller chain).
- Check for turned or protruding pins
- Check for cleanliness of components
- Check for shaft and sprocket or sheave alignment
- Check for wear on sprockets or sheaves
- Check the condition of the lubricant
- Relubricate if necessary
- Check the lubrication system if present

The frequency of maintenance checks depends upon environmental conditions such as presence of moisture, temperature extremes, corrosive atmospheres, abrasive contamination etc. The presence of shock or overloads will also reduce life expectancy and increase the requirement for regular checks.

At Least Every 6 Months

Carry out the above checks and procedures on the entire chain. If all parts of the chain cannot be accessed remove it and replace in accordance with manufactures instructions.

Chain Installation and Maintenance

Chain Protection

A new Renold chain should always be stored in its original packing until installation. Renold chain is lubricated at the factory, but this lubrication will not stand up to outdoor conditions for prolonged periods particularly where there is a salt water atmosphere.

Unprotected, lubricated chains will become contaminated with grit and other materials which will harm the chain.

Lubrication

Renold Chain should be protected against dirt and moisture and be lubricated with good quality, non-detergent petroleum based oil. A periodic reoiling is desirable as already outlined. Heavy oils and greases are generally too stiff to enter the chain working surfaces and should not be used.

Care must be taken to ensure that the lubricant reaches the bearing area of the chain. This can be done by directing the oil into the clearances between the inner and outer link plates.

The table below indicates the correct lubricant viscosity for various ambient temperatures.

Ambient Temperature Celsius	Lubricant SAE	Rating BS4231
-5 to +5	20	46 to 68
5 to 40	30	100
40 to 50	40	150 to 220
50 to 60	50	320

For the majority of applications in the above temperature ranges, a multigrade SAE 20/50 oil would be suitable.

Use of Grease

As mentioned, the use of grease is not recommended. However, if grease lubrication is essential it should be noted that applying normal greases to the outside surfaces of a chain only seals the bearing surfaces and will not work into them. This causes premature failure. Grease has to be heated until fluid and the chain immersed and allowed to soak until all air bubbles cease to rise. If this system is used the chains need regular cleaning and regreasing at intervals, depending on the loads in the lifting system.

Abnormal Ambient Temperatures

For elevated temperatures up to 250°C, dry lubricants, such as colloidal graphite or MoS₂ in white spirit or poly-alkaline glycol carriers are most suitable.

Conversely, at low temperatures between -5° and -40°C, special low temperature initial greases and subsequent oil lubricants are necessary. Lubricant suppliers will give recommendations.

Lubricating Methods

There are two basic methods of lubricating lifting systems:

- TYPE 1, Manual Lubrication.

Oil is applied periodically with a brush or oil can, preferably once every 8 hours of operation. Volume and frequency should be sufficient to just keep the chain wet with oil and allow penetration of clean lubricant into the chain joints.

Applying lubricant by aerosol can be satisfactory under some conditions, but it is important that the aerosol lubricant is of an approved type for the application, such as that supplied by Renold. This type of lubricant penetrates into the pin/ bush/ roller clearances resisting both the tendency to drip or drain when the chain is stationary and dripping when the chain is moving.

- TYPE 2, Drip or Pressurised Lubrication

Oil drips or jets are directed between the link plate edges from a lubricator. Volume and frequency should be sufficient to allow penetration of lubricant into the chain joints.

Environmental Factors

Effect of Temperature

During operation an important factor to control in a drive system is the chain temperature. Depending on the severity of the drive service, continuity of use, etc., special attention to the lubrication method may be required.

Chain temperature above 100°C should be avoided if possible due to lubricant limitations, although chain can generally give acceptable performance up to around 250°C in some circumstances.

Low temperatures reduce chain strength by embrittlement. Going in and out of cold storage can result in moisture from condensation.

Chemical Solutions or Vapours

Corrosive attack on the chain components can cause microscopic cracking. This can lead to progressive deterioration followed by dramatic failure.

Abrasives

These will cause accelerated wear and is difficult to detect at an early stage.

Dynamic/Shock Loads

These can lead to early fatigue failure of pins and plates.

All of the above conditions make it very difficult to predict chain life. It is therefore important to monitor chain performance closely until a proper schedule is established.

TYPE 1, Manual Lubrication

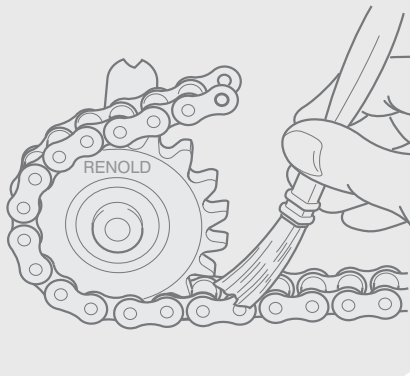

TYPE 2, Drip or Pressurised Lubrication

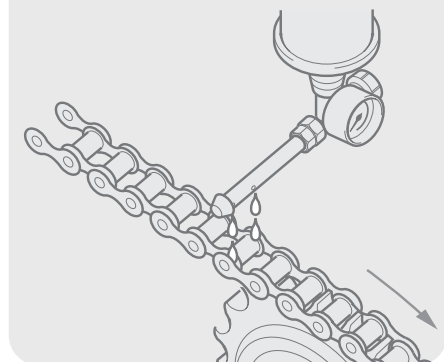

Chain Installation and Maintenance

To Measure Chain Wear

Chain wear can be ascertained by length measurement as follows:

Lay the chain on a flat surface and, after anchoring it at one end, attach to the other end a turnbuckle and a spring balance suitably anchored.

Apply a tension load by means of the turnbuckle amounting to approximately 5% of the chain breaking load.

As an alternative to the use of turnbuckle and spring balance, the chain may be measured in-situ with a nominal weight in the lifting system.

- Measure length 'M' (see Fig A) in millimetres from which the percentage extension can be obtained from the following formula:

$$\text{Percentage extension} = \frac{M - (X \times P)}{X \times P} \times 100$$

Where X = number of pitches measured
P = pitch in mm

- As a general rule, the useful life of the chain is terminated and the chain should be replaced when the percentage extension reaches 2 per cent (1 per cent in the case of extended pitch chains). For drives with no provision for adjustment, the rejection limit is lower, dependent upon the speed and layout. A usual figure is between 0.7 and 1.0 per cent extension.

It is not satisfactory to determine the elongation of a chain by checking its overall length against the nominal length of a new chain. Worn chains must be examined over their full length and then measured on that portion of the chain which has obviously had the most wear. Maximum wear occurs generally to those sections which articulate under load i.e. where the chain passes over a sprocket or sheave.

Renold Chain Wear Guide

A simple to use chain wear guide is available from Renold for most popular sizes of chain pitch (see Fig B)

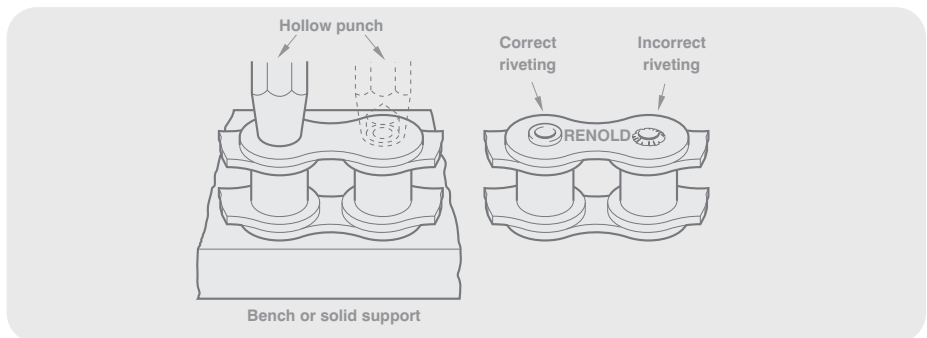
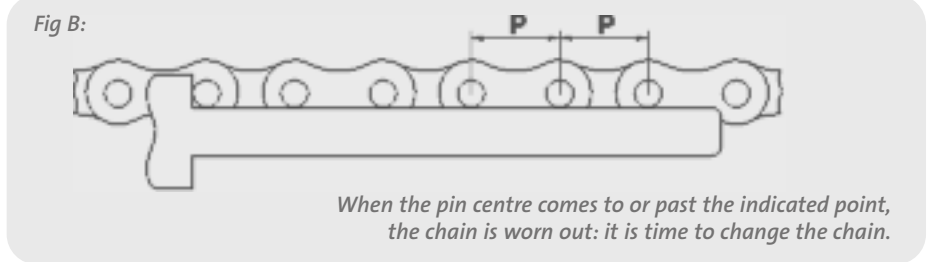
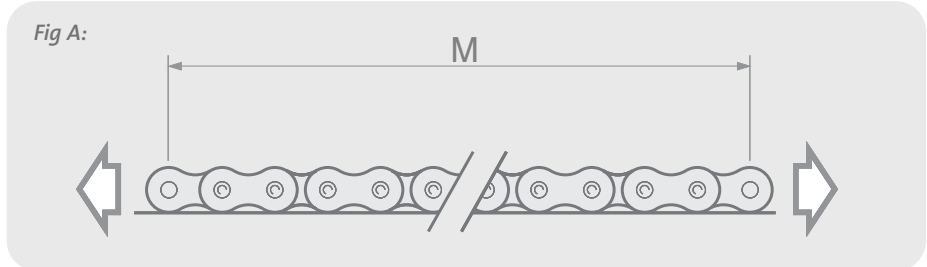

Riveting Chain

Roller Chains up to 63.5mm (2.5") Pitch

- Insert the bearing pins of the outer link (No. 107) through the inner links of the chain to be joined. If multiplex chain, assemble intermediate plates at the same time
- Provide support for the outer link (No.107) while assembling the separate outer plate. This has a force fit and is driven onto the bearing pins using a hollow punch alternatively on each pin. The plate should be driven to the point of similar clearance between outer and inner links as with the adjacent chain
- Still supporting the outer link (No.107), rivet the bearing pin ends, taking care to finish with a neat uniform spread having a similar appearance to the pins in the adjacent chain. The force required to spread the pin end will vary with the pitch of the chain, excessive riveting force should always be avoided. Except where final chain joining in-situ is necessary, the work should be carried out on a bench
- Check that the newly fitted link articulates freely

Chain Matching

Any application in which two or more strands of chain are required to work side by side would benefit from special matching procedures. These procedures only apply to roller chain and can be summarised as follows:

Length Matching

Chains are accurately measured in handling lengths between 3m and 8m and selected to give overall length uniformity of two (or more) strands.

Pitch Matching

Pitch matched chains are made from shorter subsections around 0.3 to 0.6m in length, graded and joined to give even greater accuracy on both pitch to pitch dimensions and overall lengths.

Colour Coding

The above two methods are factory applied. It is also possible to receive chain coded to give a graded length tolerance within the normal manufacturing limits of 0 to +0.15%.

Contact Renold Chain for further details.

Chain Installation and Maintenance

General

A correctly installed chain will enhance service life and ensure safe operation.

When ordering replacement chains consult your operating/service manual to ensure that the new chain or chains will be supplied to the correct size, length and configuration.

Where a lift truck has a pair of chains, a new pair should always be ordered and replaced. The replacement of only one chain will lead to premature failure of both the new and used chain.

Sprockets

Examination of the tooth faces will give an indication of the amount of wear which has occurred (Fig A). Under normal circumstances this will be evident as a polished worn strip about the pitch circle diameter on each of the sprocket teeth as shown.

If the depth of this wear 'X' has reached an amount equal to 10% of the 'Y' dimension, then steps should be taken to replace the sprocket. Running new chain on sprockets having this amount of tooth wear will cause rapid chain wear.

It should be noted that in normal operating conditions, with correct lubrication the amount of wear 'X' will not occur until several chains have been used.

Sheaves

Check the running diameter and side faces of the flanges of sheaves. There should be no evidence of side wear on the flanges (indicating malalignment). The sheave diameter should not be excessively worn.

Chain

Chain repair should not as a rule be undertaken. A correctly selected and maintained chain should gradually wear out over a period of time, but it should not fail. A length extension check will give an indication of the service life remaining.

Renold chain is prelubricated at the factory to ensure good corrosion resistance and wear properties. If a chain is dry of this lubricant due to cleaning, the chain must be relubricated before fitting to the system.

Other Points

Before refitting the chain check that the chain anchors and sheaves are undamaged. Broken, damaged or worn out anchors and sheaves must be replaced before fitting the chain or chains.

Never fit a chain with a used anchor pin. Pins may have been bent or damaged or have fatigue cracks that cannot be seen by the naked eye. Your operating/service manual will give full and detailed instructions on fitting and adjusting the chain.

Never paint chain or clean chain using steam or high pressure water jets.

If a lifting chain sustains damage due to an overload, jam-up, or by riding over the sprocket teeth or sheave flanges, it should be carefully removed from the drive and given a thorough visual examination. Remove the lubricating grease and oil to make the task easier.

Depending on the damage, it may be practicable to effect temporary repairs using replacement links. It is not, however, a guarantee that the chain has not been overstressed and so made vulnerable to a future failure.

The best policy therefore is to remove the source of trouble and fit a new chain.

Replacing Chain Sets

When replacing chain in multiple point lifting systems the entire chain set should be replaced for the following reasons:

- Used chain may have sustained fatigue cracking that will eventually cause failure.
- Used chain may have elongated which will lead to a premature replacement of a new chain running in parallel.

- The anchors holding the used chain may be at the limit of their adjustment causing misalignment of both the used and new chain.
- A new chain will have a lower rolling resistance than its mating chain causing stress on cylinder cross-heads and sheaves.
- The time and labour cost to change the second chain is minimal once the truck is stripped down ready.

Disconnecting Chain

Disconnecting Leaf Chain

- Two pins need to be removed from one joint. Both pins should be in the same outside plate. With a grinding wheel, grind the heads of both pins flush with the pin link plate. This prevents scoring damage to inside link holes during disassembly. If chain is exposed to grinding dust, chain should be cleaned and relubricated.
- Position a support ring in a clearance hole in the work surface. The support ring serves to support the bottom pin link plate and avoid damage to chain components while driving the pin through the chain.
- Drive the pin through the chain with a hammer and punch. The punch should have a diameter slightly less than the pin link plate aperture. Use a series of small blows rather than a few heavy ones.
- Repeat the above steps with the other pin in the same link.

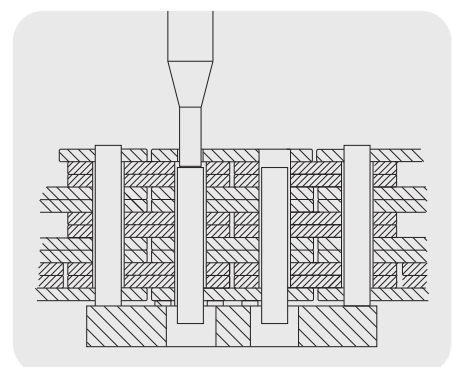
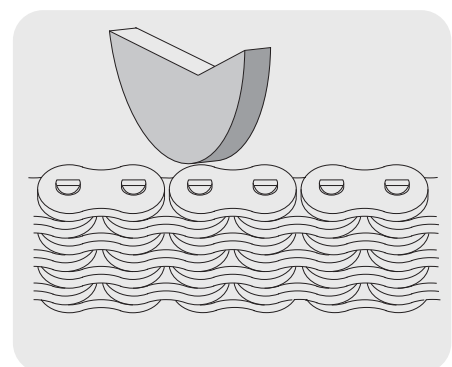
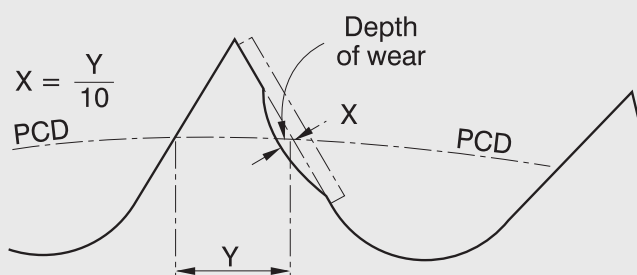

Fig A



Chain Installation and Maintenance

Disconnecting Roller Chain

Renold Chain has end softened pins and for chain up to 1" pitch the pin may be removed using a suitable chain extractor. Otherwise follow the above procedure.

In order to obtain the longest life from a leaf chain, Renold recommends the following procedures for cutting short chain lengths from a new coil or shortening an existing leaf chain.

• Method 1 - Grinding

Two pins need to be removed. Both pins should be in the same outer link plate. With a grinding wheel, grind the heads of both pins flush with the outer link plate. This will ensure that the pin when pushed out will not damage the portion of the inner link plate holes noted in Fig. B. The joint may now be easily removed with a suitable hammer and punch. If the chain is contaminated with grinding dust, it should be cleaned and re-lubricated before use.

• Method 2 - Pressing

Two pins need to be removed. Both pins should be in the same outer link plate. Arrange the joint, which is to be removed as shown in Fig. A such that it is at right angles to the line of the chain. This will ensure that the riveted wedge of the pin head when pushed out will not damage the portion of the inner link plate holes noted in Fig. B. Push the pins directly through the inner link plates using a suitable hydraulic or manual press. The movement of the pin through the outer link plate will tend to collapse the riveted end of the pin and allow it to pass freely through the inner link plate holes.

General

When using either of the above methods ensure that:

- The outer plates are not reused
- The portion of the inner link plate holes noted in Fig. B are not damaged.

Pin removal

To remove the pins, position the chain on a solid support with a clearance hole corresponding to the pin positions. Drive the pin through the first outer link plate using a suitable hammer and punch, with a series of light blows rather than one heavy blow (Method 1) or with a suitable hydraulic or manual press (Method 2).

Once the pin is clear of this outer link plate, carry out the same operation on the second adjacent pin. At this point the pins may be removed by hand or with minimal additional force and should pass unimpeded through the inner link plates. If the pin has to be forced through the inner link plates, due to

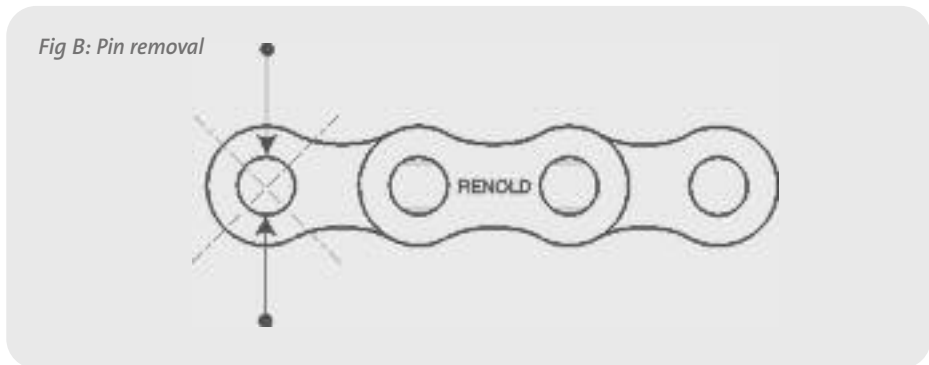
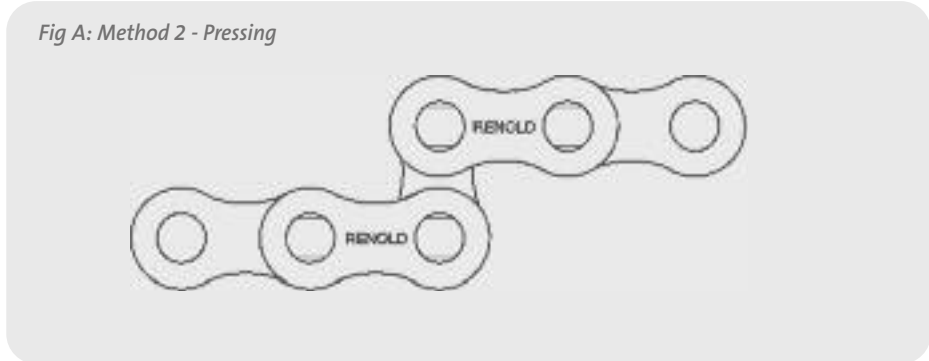

insufficient collapse of the pin head or poor grinding, excessive damage can occur to the holes of the inner link plates. Inner link plate holes should be visually checked on each cutting operation. Excessively damaged holes will have one or more very discernible grooves running in the direction of the pin removal. If excessive damage is noticed in the portion of the inner link plate holes noted in Fig. B, the chain should not be used.

Safety Warnings

Health & Safety Warning

The following precautions must be taken before disconnecting and removing a chain from a system prior to replacement.

1. Always isolate the power source from the drive or equipment.
2. Always wear safety glasses.
3. Always wear appropriate protective clothing, hats, gloves and safety shoes as warranted by the circumstances.
4. Always ensure tools are in good working condition and used in the proper manner.
5. Ensure there is no residual load in the system by supporting hung weights etc.
6. Always support the chain to avoid sudden unexpected movement of chain or components.
7. Never attempt to disconnect or reconnect a chain unless the correct procedure is fully understood.

8. Ensure that directions for the correct use of any tools are followed.
9. Never reuse individual components.
10. Never reuse a damaged chain or chain part.

General Advice

- Never mix chain from various manufacturers.
- Never build chain from individual components.
- If a chain has been damaged it is likely that parts not obviously damaged are also affected. Replace the entire chain.
- Do not electroplate chain, this can only be accomplished at the factory by plating individual components before assembly. Post electroplated chain will fail due to hydrogen embrittlement.
- Do not carry out welding operations on chain.
- Do not paint chain.
- Do not anneal or otherwise heat chain above 250°C. If a torch is used to cut chain, the chain should be discarded.
- Do not join lengths of chain together, particularly in safety critical applications.
- Note that the minimum tensile strength quoted in catalogues does not refer to the working load. Designers generally use a factor of at least 5:1 on lifting applications.

Chain Installation and Maintenance

Safety Warning FLT Chain

Never use a connecting link in any lifting application to join leaf or roller chain lengths together, in any manner that does not have the truck manufacturers approval. Misuse of connecting links will render your chain warranty void and subject the user to a safety hazard. Renold Distributors will not supply connecting links for this purpose.

When chains are sold as assemblies, the connecting pins must be fitted to the chain anchor and chain using the approved method outlined by the truck manufacturer.

If you are unsure about the correct method, contact your local Renold Chain Representative or the Truck Manufacturer direct.

The following notes highlight the common modes of failure in lifting chain.

Modes of Failure

Normal Wear

When the chain reaches the end of its normal wear life it should be replaced. It is important to measure the chain in the section that moves over the sprockets or sheaves which do the greater amount of work.

Plate Edge Wear (Fig 3)

Plate edge wear occurs where the chain runs over the sheave. This can be compared to a normal plate height by measuring an unworn portion.

Distorted or Damaged Plates

These can cause tight joints and prevent chain articulation.

Turned or Protruding Pins (Fig 4)

Inadequately lubricated or highly loaded chain generates high frictional load between pin and plates. In extreme cases the torque exceeds interference fit between the pin and the outer plates, resulting in pin turning. This ultimately causes the pin to screw out of the plates resulting in failure.

The pin head rivets should be examined to determine if the "VEE" flats are still in correct alignment. Chain with rotated/displaced heads or abnormal pin protrusion should be replaced immediately. Do not attempt to repair the chain by welding or driving the pin(s) back into the chain. Once the press fit integrity between outside plates and pins has been altered it cannot be restored.

Wear on the Pin Heads

Caused by chain misalignment. This condition damages the chain and should be corrected.

Cracked Plates (Fig 1)

Cracked plates can have a number of causes. In any event any cracks discovered in a chain will render it unsafe. Chain should be immediately replaced.

Reasons for Plate Cracking

- Fatigue cracks caused by cyclic loading beyond the chain's endurance limit, which normally start at the plate hole (point of highest stress) and perpendicular to the chain pitch line.

There is no noticeable yielding (stretch) of the material.
- Stress corrosion cracking (Fig 2) due to the presence of harsh environmental conditions. These also start at the plate hole but tend to extend in an arc-like path between the plate holes.

More than one crack can often appear on a plate. This can be caused by the presence of acid or caustic fluids or vapours in combination with

a static stress. The interference fit between a pin and plate gives sufficient static stress. This means that in the right environmental conditions, the chain can crack even if under no load. For example, the presence of battery acid fumes in a warehouse could cause cracking in a chain stored on the shelf.

- Never electroplate a chain or its components. This process liberates hydrogen, and hydrogen embrittlement cracks will appear. These are similar in appearance to stress corrosion cracks.

Plated chains have to be produced by Renold Chain under controlled conditions which ensure no embrittlement takes place.

Corrosion fatigue cracks are in appearance very similar to normal fatigue cracks.

- Corrosion fatigue results from an aggressive environment combined with a cyclic stress. (Stress corrosion cracks are caused by a static stress).

Tensile Failure (Fig 5)

Tensile failure results from repeatedly loading the chain above its elastic limit. (Approximately 65% of breaking load).

Side plates appear stretched and distorted and plate holes often elongate and break out.

Tight Joints

Tight joints do not rotate freely, resulting in high friction. This means that the lifting mechanism becomes less efficient and accelerates the onset of wear and fatigue related problems.

Fig 1



Fig 2

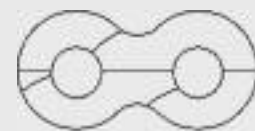

Fig 3

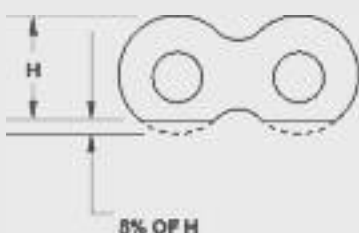

Fig 4

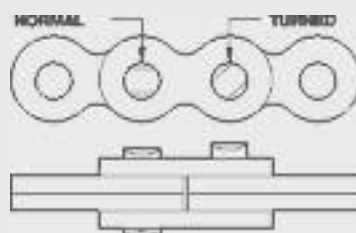



Fig 5



Chain Installation and Maintenance

Troubleshooting

Problem	Probable Cause	Solution
Anchor fails	<ul style="list-style-type: none"> High overload 	<ul style="list-style-type: none"> Replace anchor and chain set. Correct cause of overload.
Chain climbing or jumping off the sprocket or sheave	<ul style="list-style-type: none"> Chain or sprockets worn Foreign build up in the tooth gap (sprockets only) 	<ul style="list-style-type: none"> Replace the chain and sprockets/sheave if necessary. Clean the sprocket teeth of all material so that the chain engages correctly.
Chain elongation (A gradual increase over its life is normal)	<ul style="list-style-type: none"> Lubrication failure Overload conditions 	<ul style="list-style-type: none"> Replace chain and sprockets or sheaves. Check lubrication failure. Check lubrication, drive configuration and loadings. Replace chain.
Chain running hot	<ul style="list-style-type: none"> Lubrication method or type of lubrication is unsuitable for the operating speed and the load being transmitted Insufficient lubrication Chain continually hitting an obstruction Incorrect chain size selected for the speed and load 	<ul style="list-style-type: none"> Increase the lubrication frequency and quantity Consider changing lubricant Increase the frequency of lubrication in line with good maintenance practice Remove the obstruction Check the chain selection as a larger pitch or multistrand chain of equivalent capacity may be required
Corrosion pitting	<ul style="list-style-type: none"> Exposure to corrosive environment 	<ul style="list-style-type: none"> Replace chain set and protect from hostile environment
Enlarged holes 	<ul style="list-style-type: none"> Chain misaligned 	<ul style="list-style-type: none"> Replace chain set and correct cause of overload
Excessive noise	<ul style="list-style-type: none"> Misalignment of sprockets/sheaves Inadequate lubrication Worn or incorrectly fitted bearings Worn chain or sprockets/sheaves Tight joints Heavy impulsive loads Obstruction in the chain path 	<ul style="list-style-type: none"> Misalignment introduces abnormal loading and wear Recheck alignment to maintain normal drive conditions Improve the lubrication method to ensure the proper amount of lubrication is available in the bearing areas Replace or correct the bearings as these will malign the entire drive Replace the chain and, where necessary, the sprockets/sheaves Replace chain set Reduce the load Remove the obstruction

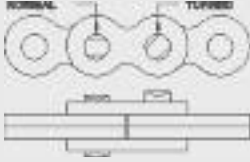

Chain Installation and Maintenance

Troubleshooting

Problem	Probable Cause	Solution
<p>Heavy wear on sprocket teeth working faces. (a bright polished appearance is normal)</p>	<ul style="list-style-type: none"> Poor lubrication Presence of abrasive 	<ul style="list-style-type: none"> Improve the method of lubrication, (see lubrication section). Check for presence of foreign materials and eliminate the source. Replace sprockets and chain if necessary.
<p>Kinks in chain (Joints tight)</p> 	<ul style="list-style-type: none"> Worn chain or sprockets/sheaves Bent pins due to overload Chain corroded Peened plate edges Dirt or foreign substance in joints 	<ul style="list-style-type: none"> Replace chain sets and sprockets/sheaves. Check lubrication. Correct overload condition, replace chain set. Clean chain with wire brush and relubricate. Replace chain set as soon as possible. Mechanical damage, remove cause. Replace chain set as soon as possible. Clean chain and relubricate.
<p>Pin fails</p> 	<ul style="list-style-type: none"> System loading is greater than the capacity of the chain 	<ul style="list-style-type: none"> Check the safety factor to determine if the chain capacity has been exceeded. Reduce high load condition. Replace with chain of larger capacity.
<p>Protruding or turned pins</p>	<ul style="list-style-type: none"> Lack of lubrication High loads 	<ul style="list-style-type: none"> Replace chain set immediately. Ensure proper lubrication regime. Replace chain set.
<p>Rust present on chain</p>	<ul style="list-style-type: none"> Inadequate lubrication. This will also affect the joints which will be discoloured, (light to dark brown) and could be rough, grooved or galled 	<ul style="list-style-type: none"> Remove several joints and check that the components are not severely damaged. Replace chain and sprockets as necessary Improve lubrication method
<p>Sheave worn</p>	<ul style="list-style-type: none"> Chain misaligned 	<ul style="list-style-type: none"> Replace chain and sheave. Correct misalignment.
<p>Side plates are worn</p>	<ul style="list-style-type: none"> Wear on the inside of the plate is caused by sprocket misalignment Wear on the top of the side plate is caused by the chain rubbing against some obstruction Normal wear on leaf chain against sheave Abnormal wear on leaf chain rubbing against guides 	<ul style="list-style-type: none"> Check and adjust sprocket and shaft alignment Remove source of rubbing by removing the obstruction Replace chain at 5% wear Check alignment, increase clearance.

Chain Installation and Maintenance

Troubleshooting

Problem	Probable Cause	Solution
<p>Side plate fails</p> 	<ul style="list-style-type: none"> • Fatigue cracks due to high dynamic load • Stress corrosion due to severe rusting or exposure to acidic or caustic medium • Tensile failure due to high overload 	<ul style="list-style-type: none"> • Reduce loads • Replace chain with higher capacity • Replace chain set and protect from hostile environment • Replace chain set and correct cause of overload
<p>Twisted chain</p> 	<ul style="list-style-type: none"> • Lubrication failure • Overload conditions 	<ul style="list-style-type: none"> • Replace chain and sprockets or sheaves • Check lubrication failure • Check lubrication, drive configuration and loadings • Replace chain
<p>Wear on the sides of the sprocket teeth</p>	<ul style="list-style-type: none"> • Drive misalignment 	<ul style="list-style-type: none"> • Check and correct sprocket and shaft alignment
<p>Worn surfaces on outside links or pin heads</p>	<ul style="list-style-type: none"> • Misalignment rubbing on guides 	<ul style="list-style-type: none"> • Check alignment and correct

Special Applications



◀ Renold supplies leaf chain to many of the world's largest truck manufacturers.

Renold heavy duty large pitch ▶
transmission chains are used
on straddle carriers transporting
ocean going containers on
docks worldwide.

Side loading fork lift trucks ▶
run on Renold leaf chain are
used to store and pick products
in warehouses worldwide.



◀ Reliability and performance with
safety built in as standard.

Safety warning

Outer Link: for high speed drives or drives operating in arduous conditions a properly riveted outer link (No 107) must always be used for optimum security, in preference to any other form of chain joint. The use of other connectors and cranked links (No 12 and No 30) must always be restricted to light duty, non-critical applications, in drives where an odd number of pitches is absolutely unavoidable. Wherever possible, drives should have sufficient overall adjustment to ensure the use of an even number of pitches throughout the useful life of the chain. A cranked link joint should only be used as a last resort.

Health and Safety at work

In the interests of safety, customers are reminded that when purchasing any technical product for use at work (or otherwise), any additional or up-to-date information and guidance, which it has not been possible to include in the publication, should be obtained by you from your local sales office in relation to the suitability and the safe and proper use of the product. All relevant information and guidance must be passed on by you to the person engaged in, or likely to be affected by or responsible for the use of the product.

Chain performance

The performance levels and tolerances of our product stated in this catalogue (including without limitation, serviceability, wear life, resistance to fatigue, corrosion protection) have been verified in a programme of testing and quality control in accordance with Renold, independent and/or international standard recommendations.

No representations or warranties are given that our product shall meet the stated performance levels or tolerances for any given application outside the performance levels and tolerances for the product's own specific application and environment.

Guidance notes

Whilst all reasonable care in compiling the information contained in this catalogue is taken, no responsibility is accepted for errors. All information contained in this catalogue is subject to change without notice.

Illustrations - The illustrations used in this catalogue represent the type of product described but the goods supplied may vary in some detail from those illustrated.

Specifications - The right is reserved to make modifications to the product to meet manufacturing conditions and/or developments (for example in design or materials).

Renold - Product can be supplied by Renold companies or representatives around the world on the standard terms and conditions of sale of the company or representative from which the product is purchased.

Copyright - Copyright Renold Power Transmission Limited 2011. All rights reserved.

Nothing contained in this publication shall constitute a part of any contract, express or implied.

For more information contact
your local sales team below or visit

www.renold.com

Australia

Tel: + 61 (0) 3 9262 3333
e-mail: melsmg@renold.com.au

Austria

Tel: + 49 (0) 5562 810
e-mail: info@renold.de

Belgium

Tel: + 32 (0) 9 242 95 50
e-mail: info@renold.be

Canada

Tel: (800) 265 9970
e-mail: inquiry@renoldcanada.com

China

Tel: + 86 21 5046 2696
e-mail: sales@renold.cn

Denmark

Tel: + 45 (0) 434 526 11
e-mail: infor@renold.com

France

Tel: + 33 (0) 320 16 2929
e-mail: contact@brampton-renold.com

Germany

Tel: + 49 (0) 5562 810
e-mail: info@renold.de

Hungary

Tel: + 49 (0) 5562 810
e-mail: sales@renold.co.hu

India

Tel: +91 (0) 4324 281283
e-mail: india.marketing@renold.com

Malaysia

Tel: + 603-5122 7880
e-mail: malaysia@renold.com

Netherlands

Tel: + 31 (0) 20 614 6661
e-mail: info@renold.nl

New Zealand

Tel: + 64 (0) 9 828 5018
e-mail: aksales@renold.co.nz

Philippines

Tel: + 63 2 829 6086

Poland

Tel: + 48 663 84 2487
e-mail: info@renold.pl

Romania

Tel: + 49 (0) 5562 810
e-mail: renold.romania@yahoo.co.uk

Russia

Tel: + 7 495 645 2250
e-mail: info@renold.ru

Scandinavia

Tel: + 45 43 45 26 11
e-mail: infor@renold.com

Singapore

Tel: + 65 6760 2422
e-mail: sales@renold.sg

South Africa

Tel: + 27 (0) 11 747 9500
e-mail: sales@renold.co.za

Sweden

Tel: + 45 (0) 434 526 11
e-mail: sweden@renold.com

Switzerland

Tel: + 41 (0) 44 824 8484
e-mail: duebendorf@renold.com

UK

Tel: + 44 (0) 161 498 4600
e-mail: ukchain@renold.com

USA

Tel: (800) 251 9012
e-mail: sales@renoldjeffrey.com

Whilst all reasonable care is taken in compiling the information contained in this brochure, no responsibility is accepted for printing errors.

All information contained in this brochure is subject to change after the date of publication.

© Renold Power Transmission 2013.
Ref: REN3 / ENG / 10.13



Want to find out more?
Scan this QR code with your smartphone.
No QR reader? Simply download one from your app store.

RENOLD
Superior Chain Technology